



TiM150-3010300

TiM1xx

2D LIDAR SENSORS

SICK
Sensor Intelligence.



Ordering information

| Type | Part no. |
|----------------|----------|
| TiM150-3010300 | 1093243 |

Other models and accessories → www.sick.com/TiM1xx



Detailed technical data

Features

| | |
|------------------------------|--|
| Measurement principle | HDDM ⁺ |
| Application | Indoor |
| Light source | Infrared (850 nm) |
| Laser class | 1 (IEC 60825-1:2014, EN 60825-1:2014) |
| Aperture angle | Horizontal 200° |
| Scanning frequency | 14.5 Hz |
| Angular resolution | 1° |
| Working range | 0.05 m ... 10 m |
| Scanning range | At 10% remission 2.8 m ... 3 m, depending on the angle |

Mechanics/electronics

| | |
|-------------------------------|---|
| Connection type | 1 x 5-pin M12 male device connector (rotatable) |
| Supply voltage | 10 V DC ... 28 V DC ¹⁾ |
| Power consumption | Typ. 2.7 W |
| Housing color | Light blue (RAL 5012) |
| Enclosure rating | IP65 (IEC 60529:1989+AMD1:1999+AMD2:2013) |
| Protection class | III (IEC 61140:2016-1) |
| Weight | 122 g, without connecting cables |
| Dimensions (L x W x H) | 60 mm x 60 mm x 75.8 mm |

¹⁾ When using IO-Link output $V_s > 18$ V.

Performance

| | |
|--------------------------------------|-----------------------|
| Response time | Typ. 70 ms |
| Detectable object shape | Almost any |
| Systematic error | $\pm 40 \text{ mm}^1$ |
| Statistical error | 30 mm^1 |
| Integrated application | Field evaluation |
| Number of field sets | 1 field set |
| Simultaneous evaluation cases | 1 (2 fields) |

¹⁾ Typical value; actual value depends on environmental conditions.

Interfaces

| | |
|---------------------------|------------------------------------|
| IO-Link | ✓ |
| Function | AUX, parameterization |
| Digital inputs | 1 |
| Digital outputs | 2 (Push-pull) |
| Delay time | 69 ms ... 30,015 ms (configurable) |
| Dwell time | 69 ms ... 30,015 ms (configurable) |
| Optical indicators | 2 LEDs (ON, switching status) |

Ambient data

| | |
|--|---|
| Object remission | 4 % ... 1,000 % (reflectors) |
| Electromagnetic compatibility (EMC) | IEC 61000-6-3:2006+AMD1:2010 / IEC 61000-6-2:2005 |
| Vibration resistance | |
| Sine resonance scan | 10 Hz ... 1,000 Hz ¹⁾ |
| Sine test | 10 Hz ... 150 Hz, 1 g, 1 frequency cycles ¹⁾ |
| Noise test | 10 Hz ... 200 Hz, 5 g RMS, 2 h ²⁾ |
| Ambient operating temperature | -10 °C ... +50 °C |
| Storage temperature | -30 °C ... +70 °C |
| Permissible relative humidity | ≤ 95 %, Non-condensing ³⁾ |
| Ambient light immunity | 30,000 lx |

¹⁾ IEC 60068-2-6:2007.

²⁾ IEC 60068-2-64:2008.

³⁾ EN 60068-2-30:2005.

General notes

| | |
|--------------------|---|
| Note on use | The sensor does not constitute a safety component as defined by relevant legislation on machine safety. |
|--------------------|---|

Classifications

| | |
|---------------------|----------|
| ECl@ss 5.0 | 27270990 |
| ECl@ss 5.1.4 | 27270990 |
| ECl@ss 6.0 | 27270913 |
| ECl@ss 6.2 | 27270913 |
| ECl@ss 7.0 | 27270913 |
| ECl@ss 8.0 | 27270913 |

| | |
|-----------------------|----------|
| ECl@ss 8.1 | 27270913 |
| ECl@ss 9.0 | 27270913 |
| ECl@ss 10.0 | 27270913 |
| ECl@ss 11.0 | 27270913 |
| ETIM 5.0 | EC002550 |
| ETIM 6.0 | EC002550 |
| ETIM 7.0 | EC002550 |
| ETIM 8.0 | EC002550 |
| UNSPSC 16.0901 | 46171620 |

Dimensional drawing (Dimensions in mm (inch))

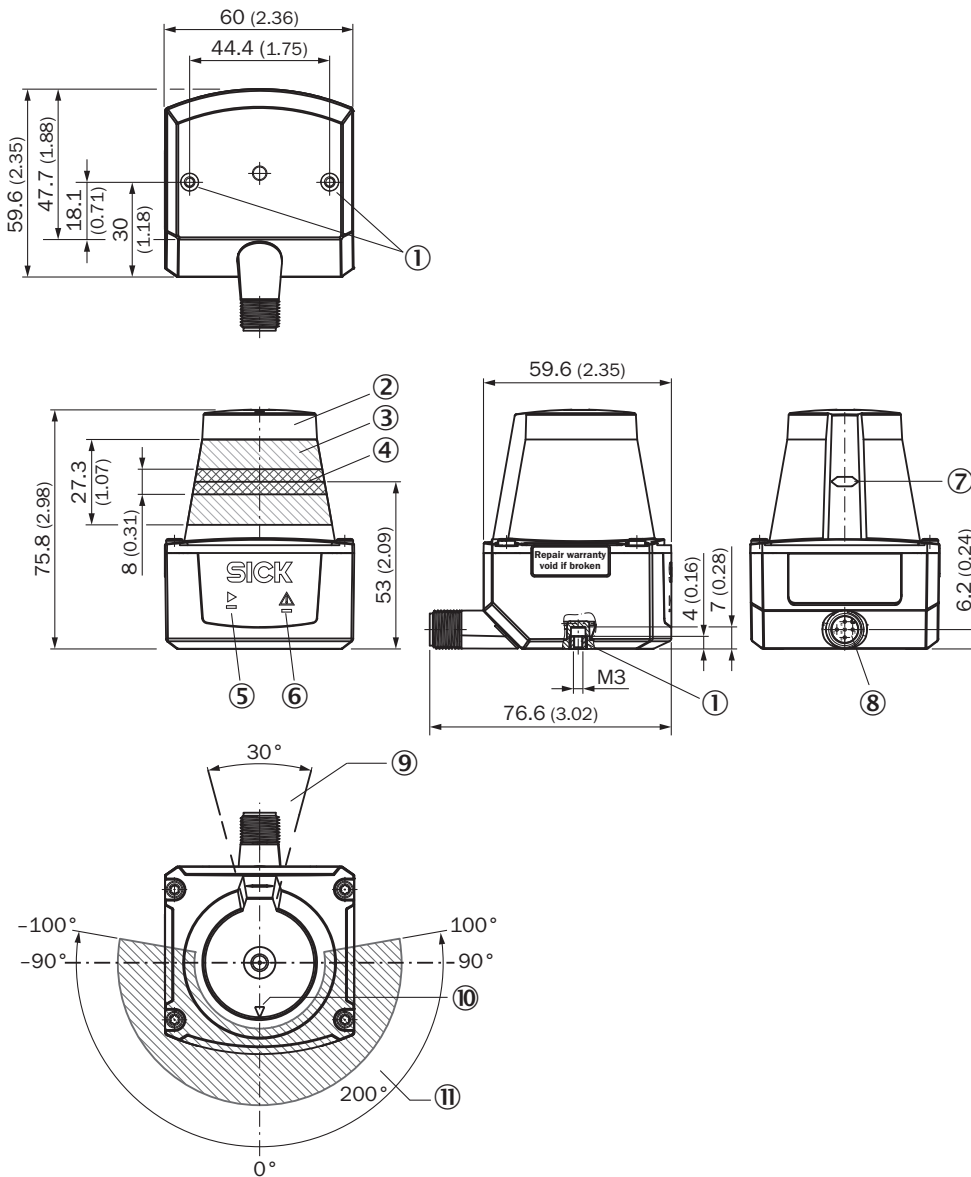

- ① M3 threaded mounting hole, 2.8 mm deep (blind hole thread), max. tightening torque 0.7 Nm
- ② Optical hood
- ③ Receiving range (light inlet)
- ④ Transmission range (light emission)
- ⑤ Green LED
- ⑥ Red LED
- ⑦ Marking for the position of the light emission level
- ⑧ 5-pin M12 male connector (rotatable)
- ⑨ Area in which no reflective surfaces are allowed for mounted devices
- ⑩ Bearing marking to support alignment (0° axis)
- ⑪ Aperture angle 200° (scanning angle)



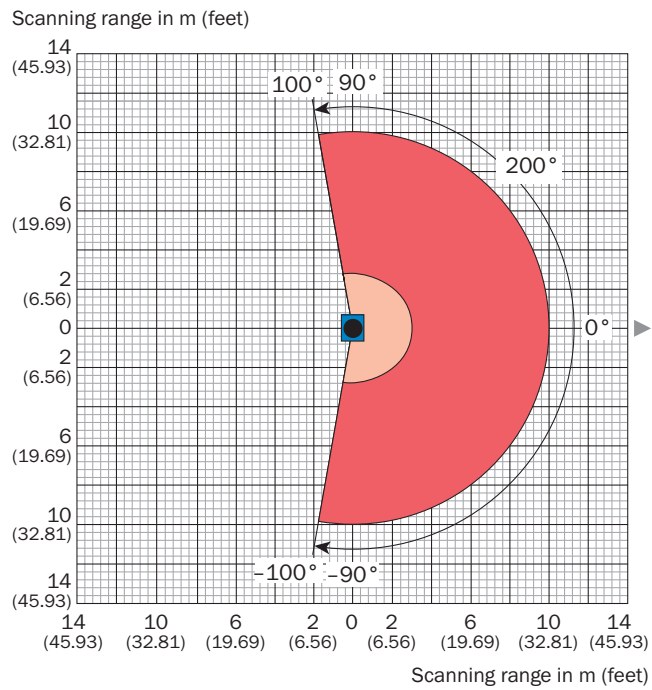

Working range diagram



- Scanning range max. 10 m (32.81 ft)
- Scanning range 2.8 m to 3 m (9.19 ft to 9.84 ft) for objects with 10 % remission, dependent on the angle

Recommended accessories

Other models and accessories → www.sick.com/TiM1xx

| | Brief description | Type | Part no. |
|---|---|--------------------------------|----------|
| Connection modules | | | |
|  | IO-Link V1.1 Class A port, USB2.0 port, optional external power supply 24V / 1A | IOLA2US-01101 (SiLink2 Master) | 1061790 |
| Mounting brackets and plates | | | |
|  | Mounting kit | Mounting kit | 2082188 |
|  | Q-lock mounting system | Q-Lock mounting kit | 2083311 |
| Plug connectors and cables | | | |
|  | Head A: female connector, M12, 5-pin, straight, A-coded Head B: Flying leads Cable: Sensor/actuator cable, PUR, halogen-free, unshielded, 2 m | YF2A15-020UB5XLEAX | 2095617 |

| | Brief description | Type | Part no. |
|---|--|--------------------|----------|
|  | Head A: female connector, M12, 5-pin, straight, A-coded Head B: male connector, M12, 5-pin, straight, A-coded Cable: Sensor/actuator cable, PUR, halogen-free, unshielded, 2 m | YF2A15-020UB5M2A15 | 2096009 |

Recommended services

Additional services → www.sick.com/TiM1xx

| | Type | Part no. |
|---|--|----------|
| Product, system, and software training | | |
| <ul style="list-style-type: none"> • Range of services: The training contents relate to the following 2D and 3D LiDAR sensors: LMS series, MRS1000, MRS6000, NAV series or TiM series, Training format and location can be worked out in collaboration with SICK | Training LMS/MRS/NAV/TiM | 1612234 |
| Commissioning | | |
| <ul style="list-style-type: none"> • Product area: 2D LiDAR sensors, 3D LiDAR sensors • Range of services: Inspection of connection, fine adjustment, configuration of monitored areas, configuration and optimization of parameters of the LMS/MRS/NAV/TiM as well as tests, Setup of previously defined functions of basic settings, parameters of field application, filters for raw data output and product-specific configuration • Travel expenses: The prices do not include travel costs such as hotel, flight, travel time and expenses. • Duration: Additional work will be invoiced separately | Commissioning LMS/MRS/NAV/TiM/LRS (Prime package) | 1680672 |
| Maintenance | | |
| <ul style="list-style-type: none"> • Product area: 2D LiDAR sensors, 3D LiDAR sensors • Range of services: Inspection, analysis and restoring of defined functions, Inspection and adaptation of basic settings, parameters of field application, filters for raw data output, and product-specific configuration • Duration: Additional work will be invoiced separately • Travel expenses: The prices do not include travel costs such as hotel, flight, travel time and expenses. | Maintenance LMS/MRS/NAV/TiM/LRS | 1682593 |
| Warranty extensions | | |
| <ul style="list-style-type: none"> • Product area: Identification solutions, machine vision, Distance sensors, Detection and ranging solutions • Range of services: The services correspond to the scope of the statutory manufacturer warranty (SICK general terms and conditions of purchase) • Duration: Five-year warranty from delivery date. | Extended warranty for a total of five years from delivery date | 1680671 |

SICK AT A GLANCE

SICK is one of the leading manufacturers of intelligent sensors and sensor solutions for industrial applications. A unique range of products and services creates the perfect basis for controlling processes securely and efficiently, protecting individuals from accidents and preventing damage to the environment.

We have extensive experience in a wide range of industries and understand their processes and requirements. With intelligent sensors, we can deliver exactly what our customers need. In application centers in Europe, Asia and North America, system solutions are tested and optimized in accordance with customer specifications. All this makes us a reliable supplier and development partner.

Comprehensive services complete our offering: SICK LifeTime Services provide support throughout the machine life cycle and ensure safety and productivity.

For us, that is “Sensor Intelligence.”

WORLDWIDE PRESENCE:

Contacts and other locations –www.sick.com